

The effect of turning frequency on the compost dynamics and quality derived from empty fruit bunches, *Azolla microphylla*, and active organic fertilizer

Durain Parmanoan¹, Anni Faridah², Bambang Trisakti^{3,4}, Rivaldi Sidabutar^{3,4*} , Irvan^{3,4}, Vikram Alexander³, M. Thoriq Al Fath³, Nisaul Fadilah Dalimunthe³, Hiroyuki Daimon⁵, Mohd Sobri Takriff⁶

¹ Department of Mechanical Engineering, Faculty of Engineering, Universitas Negeri Padang, Padang 25171, Indonesia

² Faculty of Tourism and Hospitality, Universitas Negeri Padang, Padang 25171, Indonesia

³ Department of Chemical Engineering, Faculty of Engineering, Universitas Sumatera Utara, Jl. Almamater Kampus USU, Medan 20155, Indonesia

⁴ Waste-to-Industrial Sustainable Energy Center, Universitas Sumatera Utara, Medan 20155, Indonesia

⁵ Department of Applied Chemistry and Life Science, Toyohashi University of Technology, Toyohashi 441-8580, Japan

⁶ Mechanical and Nuclear Engineering Department, College of Engineering, University of Sharjah, Sharjah Emirate 61467, United Arab Emirates

* Corresponding author's e-mail: rivaldi@usu.ac.id

ABSTRACT

The composting process of palm oil empty fruit bunches (EFB) and *Azolla microphylla*, supplemented with active organic fertilizer (AOF), presents an alternative method for utilizing solid palm oil mills waste. The purpose of this study is investigate the turning frequencies effect during composting on the degradation rate of EFB and *Azolla microphylla* using AOF in a basket composter to produce high-quality compost. The process involves cutting EFB to 1–3 cm pieces, mixing it with *Azolla microphylla* in an 80:20 ratio, and adding AOF to achieve an optimal moisture content (MC) of 55–65%. MC is maintained at these levels by periodically adding AOF. The turning frequencies tested include once per day, every 2 days, every 3 days, every 4 days, and every 5 days. Analyzed parameters were temperature, MC, pH, water holding capacity (WHC), volatile suspended solids, electrical conductivity (EC), and C/N ratio. Results indicate it takes 30 days to generate compost, with the optimal degradation of EFB and *Azolla microphylla* achieved at a turning frequency of once every 2 days, yielding values of pH 8.7, MC 55.72%, WHC 77%, EC 2746 $\mu\text{S}/\text{cm}$, and a C/N ratio of 14.83.

Keywords: composting, palm oil empty fruit bunches, turning frequency.

INTRODUCTION

Palm oil is one of the plantation commodities that plays a significant role in Indonesia's economic activities. Palm oil is also one of Indonesia's export commodities, and it is essential as a source of foreign exchange in addition to oil and gas [Anonymous, 2014]. The palm oil industry in Indonesia tends to increase from year to year. This growth is evident in the amount of production and exports from Indonesia and the growth in palm oil

plantations [Anonymous, 2016]. In the processing process, in addition to producing crude palm oil and palm kernel, palm oil mills also produce waste, namely liquid waste of palm oil mill effluent (POME) and solids such as palm oil empty fruit bunches (EFB), fiber, and shells [Baharuddin et al., 2010]. Each processing of fresh fruit bunches will produce EFB as much as 24% of the total waste [Putra et al., 2013].

Previously, EFB was used within a burning facility to be ashed. The ash from the burning of

EFB's comparatively high potassium concentration makes it suitable for use as fertilizer, namely $\pm 30\%$. However, this burning process is now prohibited based on the Decree of the Minister of State for the Environment No. 15 of 1996 concerning the blue-sky program to prevent air pollution. So EFB is now mainly used as mulch (plant cover material) namely placing EFB around young oil palm tree trunks [Anonymous, 1996]. This mulch can function as a weed controller, prevent erosion, and maintain soil moisture [Suhaimi and Ong, 2001]. However, the distribution of EFB to the field as mulch certainly requires high transportation and labor costs. In addition, the process of forming compost from mulch takes a long period, based on environmental variables. Therefore, before being spread out in the field or given to farmers, EFB must to be composted around oil palm plantations.

Composting is one of the efforts to process solid waste biologically. Composting methods are divided into two, namely aerobic and anaerobic composting. Aerobic composting is more accessible and, if implemented correctly, can reduce the volume of solid waste. However, this method must also supply oxygen to the pile of solid waste. While anaerobic composting is more challenging to implement, hane production is easier to control and utilize [Karagiannidis et al., 2010]. Takakura Home Method (THM) is a composting method developed by Mr. Koji Takakura, an environmental engineer from JPec Co. Ltd, to solve the waste management problem in Surabaya, Indonesia. This was implemented in 2004 as a composting method to solve the problem of solid waste processing in the community, especially in managing urban waste problems [Gotaas, 1956]. Takakura is a composter made of a basket lined with carpet on the inside to prevent insects from entering. This composting method with Takakura allows for easy, hygienic, and good-quality compost production in a short time [Association, 2007].

Previous studies have been conducted to determine the best composting process. Baharuddin et al. conducted EFB composting with POME anaerobic sludge originating from a 500 m³ closed anaerobic methane digester tank, with EFB cut sizes of 15-20 cm and turning 3 times a week. Obtaining a short composting processing time of 40 days resulting in a 12.4 finalized ratio of C to N and a pH in the compost pile of 8.1–8.6 [Baharuddin et al., 2010]. The research conducted by Tambun. was carried out by cutting the EFB

size according to the variation, then putting it into a Takakura basket and adding AOF until the moisture content (MC) of the material reached the optimum MC of 55–65% and the variation in EFB cut sizes carried out was <1 cm, 1–3 cm, 4–7 cm, 8–11 cm, and 12–15 cm. The study results shown average compost had matured in ± 40 days, and the greatest deterioration for 40 days was obtained at a size of 1–3 cm with pH 9, MC 52.69%, WHC 76%, C 23.81%, N 1.96% and C/N 12.15 [Tambun, 2015]. A more comprehensive analysis needs to be done to provide a more complete picture of the composting process and the quality of the final compost. Many things affect the composting process, and various efforts can be made to obtain good compost results from EFB raw materials, such as carrying out various composting treatments and adding other organic materials. *Azolla microphylla* as a mixture with EFB is a novelty in this study.

Azolla microphylla is a water fern plant that lives in symbiosis with Cyanobacteria that can fix nitrogen. This plant is indirectly able to bind free nitrogen in the air. With the help of the *Anabaena azollae* microorganism, the free nitrogen bound from the air will be converted into a form available to plants. This symbiosis causes *Azolla microphylla* to have good nutritional quality. *Azolla microphylla* is often found in agricultural land environments, especially in rice fields that are usually flooded. The growth of *Azolla microphylla* in rice fields during the rice production period is considered a nuisance plant (weed), so *Azolla microphylla* handling is carried out as with other weeds. Controlling *Azolla microphylla* in rice fields is usually done by mechanical or technical means, such as removing *Azolla microphylla* from the land mechanically, using tools, or manually [Sudjana, 2014]. Therefore, *Azolla microphylla* needs to be utilized so that when the production of *Azolla microphylla* is considered a nuisance, it can be used to make fertilizer rather than being destroyed.

This study aims to obtain information on the effect of the frequency of composting turning of EFB and *Azolla microphylla* on the degradation rate of composting with active organic fertilizer (AOF) using a basket composter to produce good quality compost. The importance of this study lies in the composting process for EFB, a typical solid waste from palm oil mills. By investigating the use of *Azolla microphylla*, AOF, and the impact of different turning frequencies on compost

degradation, this study provides valuable insights into how to efficiently convert this waste into high-quality compost (Figure 1). This approach not only improves waste management but also encourages the use of sustainable agricultural by-products. Effective composting can reduce the environmental footprint of palm oil production and offer a viable alternative for waste utilization. These findings will help refine composting practices, making them more efficient and productive. Ultimately, this study supports the development of sustainable agricultural practices and waste reduction strategies. These findings are essential for chemical engineers who want to optimize waste management processes and develop high-quality composting methods.

Dolok Masihul, Serdang Bedagai, Sumatra Utara, Indonesia. The EFB characteristics shown in Table 1. Distilled water, *Azolla microphylla*, and active organic fertilizer (AOF) from the processing of POM liquid waste from the Pilot Plant of Biogas Power, Pusdiklat, Pusdiklat Lembaga Penelitian dan Pengabdian Masyarakat, Universitas Sumatera Utara, Medan, Indonesia. The characteristics of the *Azolla microphylla* and AOF shown in Table 2 and Table 3. The equipment used in this study includes a cutter, beaker glass, scales, thermometer, digital pH meter, ruler, and Takakura composter. The dimensions and illustrations of the Takakura composter used in this study can be seen in Figure 2.

METHODOLOGY

Empty fruit bunches (EFB) obtained from the Tunas Harapan Sawit Palm Oil Mill (POM),

Composting procedure

The composter made from empty baskets is weighed and recorded as the initial weight. empty fruit bunches are cut into 1–3 cm sizes. Then, the EFB is put into the composter, and *Azolla*

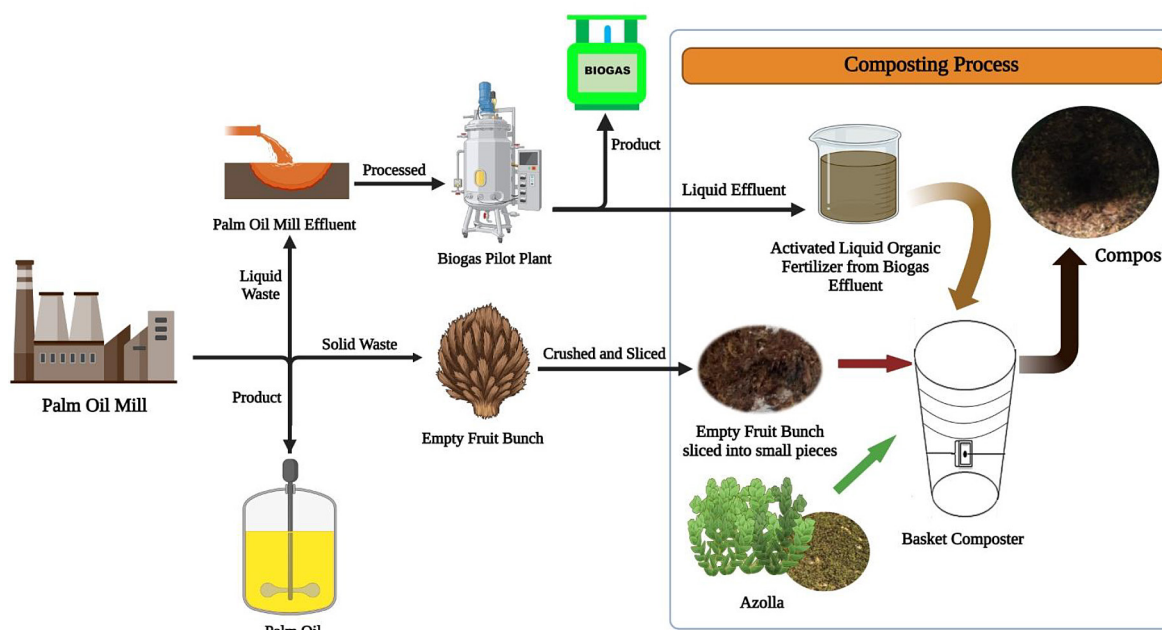

Figure 1. The process arrangement for composting

Table 1. The characteristics of the EFB

Parameter	Unit	Value	Measurement method
Moisture	(%)	50.73	SNI 03-1971-1990
pH	–	8.1	Using a digital pH meter
C	(%)	12.10	Walkley & Black method
N	(%)	0.19	Kjeldahl method
C/N	–	63.68	Division of levels C/N
WHC	(%)	35	ASTM D7367-07

Table 2. The characteristics of *Azolla microphylla*

Parameter	Unit	Value
P ₂ O ₅	(%)	2.02 – 2.10
K ₂ O	(%)	9.06 – 9.72
C	(%)	40.75 – 42.88
N	(%)	2.80 – 3.04
C/N		14.11 – 14.55
Ca	(%)	5.88 – 6.20
Mg	(%)	0.06 – 0.09

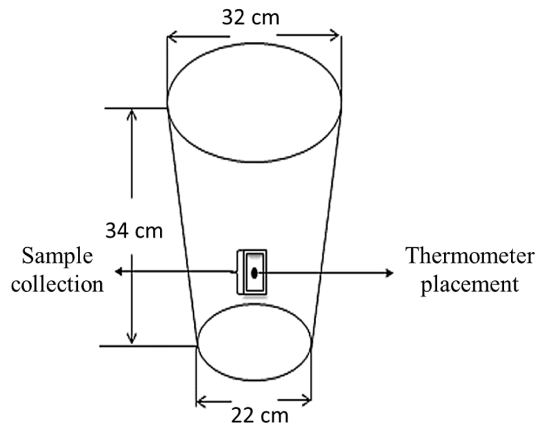

Figure 2. Schematic and dimensions of the Takakura composter used in this study

microphylla is added with a ratio of 80:20 and put into the composter until the basket is complete (as much as 2 kg). After that, active organic fertilizer is added until the composting moisture content reaches 55–65% and is maintained with this addition during the composting process. Variations in turning frequency are carried out until the 60th day with variations of turning 1 day, 2 days, 3 days, 4 days, and 5 days. Weight measurements are taken every day before turning. Sampling is carried out at the sampling point before the turning process. Temperature measurements are taken every day, in the morning and evening, before the turning process. pH

analysis is carried out every day. Moisture content analysis is carried out every day before the turning process. C/N analysis is carried out every 10 days until the C/N value.

Moisture content analysis procedure

The sample weighed as much as 3 g at the top, middle, and bottom sample locations.. The empty cup was weighed questioningly. The weighed sample was put into the cup. The filled cup was weighed questioningly. The weight of the sample in the cup was calculated as the initial weight of the sample. Put into the oven, the temperature was set at 120 °C for 4 hours. Cooled in a desiccator. The weight was weighed again. The formula calculated of moisture content (MC) using Equation (1):

$$MC = \frac{W_s - W_d}{W_s} \times 100\% \quad (1)$$

where: *W_s* – initial weight of sample (g),
W_d – sample weight after drying (g).

pH analysis procedure

pH measurements were carried out on compost samples using a daily digital pH meter. Weighing 1 g of sample, we placed it in a beaker glass. 100 mL of distilled water was added to the tube. Shake on a magnetic stirrer for 30 minutes. The pH of the compost suspension was measured on a pH meter.

Temperature analysis procedure

Temperature measurements were carried out using a mercury thermometer in three places: at the base of the pile, in the center or middle of the pile, and on the surface of the compost pile. They were carried out twice daily, namely in the morning and evening.

Table 3. The characteristics of AOF

Parameter	Unit	Value	Measurement method
C	(%)	0.58	Walkley & Black method
N	(%)	0.10	Kjeldahl method
C/N		5.8	Division of levels C/N
pH		8.09	Using a digital pH meter
P ₂ O ₅	(%)	0.016	
K ₂ O	(%)	0.167	
COD	mg/l	1,580	

Water holding capacity analysis procedure

Water holding capacity (WHC) or water binding capacity is expressed in percent units (%), according to SNI 19-7030-2004. The basis for determining water holding capacity is the level of water decomposition added to water that successfully passes through the filter paper in the analysis bucket in 24 hours. Sifted 10 grams of mature compost. Put the sifted compost into a perforated bucket lined with filter paper. Then add 10 mL of water and let it sit for 24 hours. Calculate the volume of water that successfully passes through the filter paper with the Equation (2):

$$WHC = \frac{Va - Vb}{100} \times 100\% \quad (2)$$

where: *Va* – volume of water added (10 mL),
Vb – volume of water passing through filter paper (mL).

Electrical conductivity analysis procedure

Electrical conductivity is a number that indicates a solution’s ability to conduct electric current. It is expressed in dS/m units. Place 10 grams of compost in a glass beaker. Add 20 mL of water. Stir for 15 minutes. Place the electrical conductivity meter in a 50 mL 0.01 N KCl solution. Adjust the instrument until it shows 1.412 dS/m. Place the electrical conductivity meter in the suspended sample. Record the results obtained.

Comparative analysis of C/N and other organic materials

C/N analysis and other organic materials will be carried out in Laboratorium Riset dan Teknologi, Fakultas Pertanian, Universitas Sumatera Utara, Medan, Indonesia. Meanwhile, the Microbial Count analysis was conducted in Laboratorium Mikrobiologi, Fakultas Matematika dan Ilmu Pengetahuan Alam (MIPA), Universitas Sumatera Utara, Medan, Indonesia.

RESULTS AND DISCUSSIONS

Compost profile and analysis based on temperature and moisture content

The composting process’s sustainability in the composter with the turning treatment can be seen from the temperature variations that occur during the composting process. Daily compost measurements of temperature were carried out in situation of morning and evening, while the amount of moisture content (MC) analysis only done in the morning. The temperature profile tended to decrease during the composting process, although there were some points that increased but were relatively minor, such as at 7–8 days, 15–19 days, 23–24 days, and 33–34.

The temperature analysis result profile as shown in Figure 3. The average maximum temperature this composting was 39 °C in the morning,

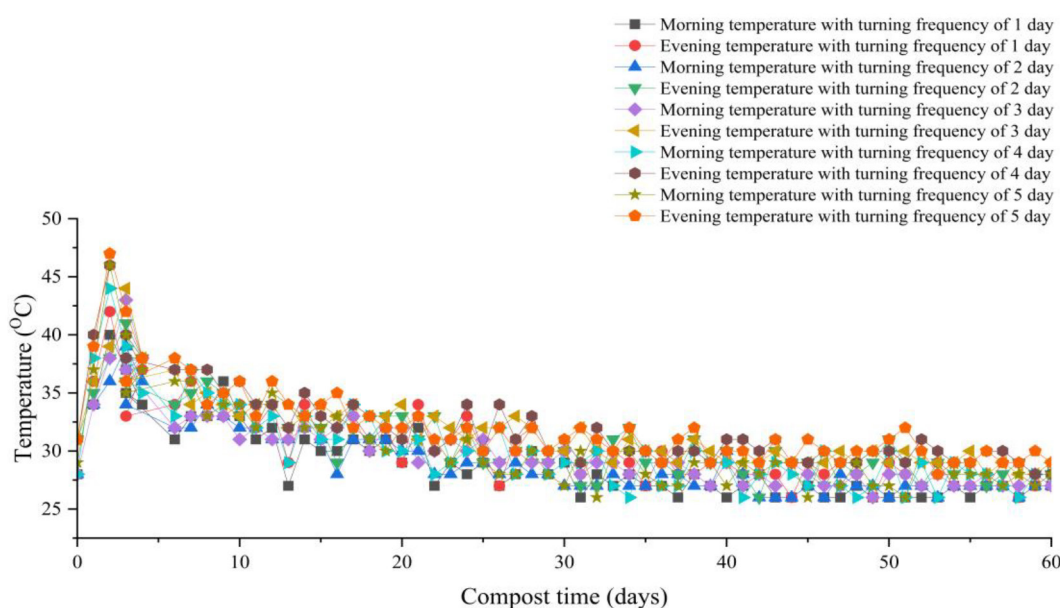

Figure 3. Temperature profile of EFB and *Azolla microphylla* composting against composting time with pile turning once a day, once every 2 days, once every 3 days, once every 4 days, and once every 5 days

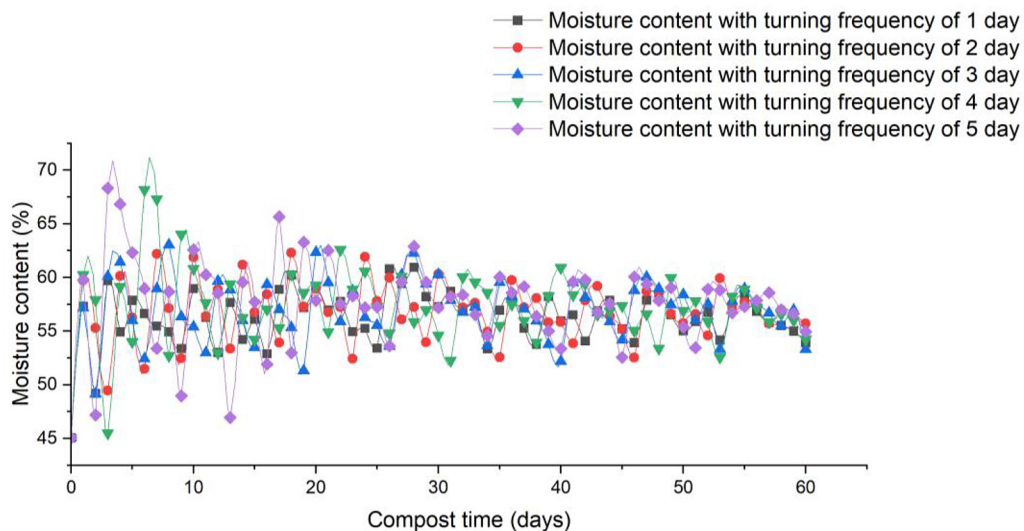

Figure 4. Moisture content profile of EFB and *Azolla microphylla* composting against composting time with pile turning once a day, once every 2 days, once every 3 days, once every 4 days, and once every 5 days

and the average maximum temperature for the afternoon was 41 °C. After that, the temperature gradually started to rise to decrease in 60th day. Shen et al. [2011] and Siong et al. [2009] stated that after a rapid increase in temperature, the temperature would slowly decrease, indicating that the degradation process slowed down along with the depletion of nutrient availability.

MC is an essential parameter for optimizing the composting process. According to Siong et al., the dependence of microbes on water to support their growth can affect the biodegradation of organic materials [Siong et al., 2009]. In this study, the addition of AOF to EFB and *Azolla microphylla* and the addition of microbes and nutrients also maintain the MC value at around 55–65%. The MC analysis result profile can be seen in Figure 4. The MC profile is visible against composting time. The initial MC before adding AOF was 45.06%, then 1.18 liters of AOF was added so that the MC value became 57.33% in Composter 1, 59.73% in Composter 2, 59.77% in Composter 3, 60.23% in Composter 4; 57.17% in composter 5. Each stirring caused the MC to decrease during the composting process, but at a certain point, there was a deviation. This happened because of the addition of AOF to the pile, whose MC value was below 55%. This is according to what was reported by Tiquia et al. [2002], which is that elevated temperatures in composting could result in continuous loss of water in evaporation.

The final MC in composters 1, 2, 3, 4, and 5 were obtained at 53.93%, 55.72%, 53.30%, 54.23%, and 54.96%. This value is close to the

MC value obtained in previous studies. As reported by Siong et al. [2009], an MC of 50% was obtained, and Baharuddin et al. [2010] obtained an MC of 52%. Tiquia et al. [2001] also reported that a water content of around 40 to 60% is needed for the survival of microorganisms, while a content exceeding 80% can kill aerobic microbes due to lack of air. Therefore, adding AOF is crucial to maintaining biological activity and providing a nitrogen source.

Compost analysis based on pH

To see the sustainability of the composting process, it is necessary to measure the pH of the compost in the composter every day. Figure 5 shows the changes in pH over composting time during composting. The pH range for 60 days of composting ranged from 6.8 to 9.3, indicating conditions tending to be alkaline. The pH increased in the first 11 days and remained constant until the 60th day.

Changes in pH during the composting process are caused by microbial activity [Kanam et al., 2011; Nutongkaew et al., 2011]. The increase in pH until the 11th day to a scale of 9.2 occurred because N changed to NH_3 or NH_4^+ in the ammonification process so the pH increased [Karagiannidis et al., 2010]. However, on the twelfth day, it tended to decrease to a scale of 9.0. This pH change was caused by the ammonium evaporation process and the release of hydrogen ions due to the nitrification process [Baharuddin et al., 2009].

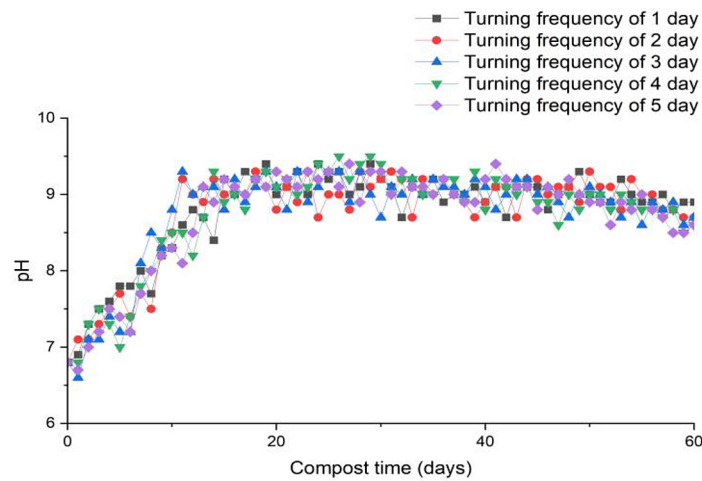

Figure 5. Changes in pH over composting time during composting

In general, the circumstances surrounding composting tended being alkaline, ranging from 6.8 to 9.3. This happened because of the influence of the pile turning, which caused CO₂ not to be confined to the vacant space between the particles of compost, thus preventing the conditions of acidic in the pile or a decrease in the pH [Tiquia et al., 2002; UNEP, 2005]. Increasing the pH to alkaline conditions is suitable for composting because alkaline conditions can inhibit the growth of pathogens, such as fungi, that can live in acidic conditions [Saidi et al., 2008].

Effect of turning frequency on volatile suspended solid

To see the growth of microbes during the composting process, it is necessary to analyze

the number of bacteria. So, modifications to the quantity of colonies of bacteria can be seen while the process of composting is underway. VSS is a way to measure microorganisms and biomass production indirectly [Trisakti et al., 2015]. The volatile suspended solid (VSS) concentration is usually utilized as a gauge of biomass output and growth of microbial [Ghanimeh et al., 2012]. Likewise, according to Trisakti et al. [2015], the microbial growth profile can be described from changes in VSS concentration.

Figure 6 shown changes in the number of microbes against composting time. The number of microbes on the first day for 1×daily turning was 205,780 mg/L; on 1×2-day turning was 205,940 mg/L; on 1×3-day turning was 208,260 mg/L; on 1×4-day turning, was

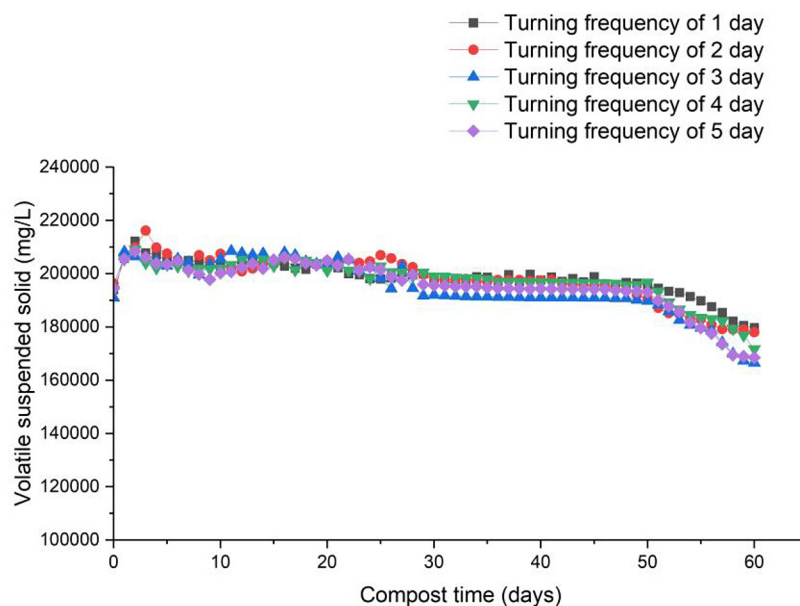

Figure 6. Effect of turning frequency on volatile suspended solid

205,380 mg/L, and on 1×5-day turning was 205,520 mg/L after the addition of AOF. Then, there was an increase in the number of microbes until the third day; the increase was caused by the addition of AOF as a nutrient to the microbes. On the 4th to 27th day, the number of microbes fluctuated up and down because the microbes that were still carrying out the biodegradation process in the composter were treated with repairs, which caused the number of microbes to decrease. AOF was added, which caused the number of microbes to increase again, causing an up-and-down fluctuation. Then, after the 27th day, the number of microbes tended to decrease with the composting time. This decline is caused by the supply of easily decomposed materials running out and the maturation stage starting, so the number of microbes will continue declining.

The effect of turning frequency on changes in C/N values

To determine the quality of the compost produced, it is necessary to measure the C/N ratio. In this study, the measurement of C/N values was limited to only two composters. Figure 7 shown the effect of turning frequency on changes in C/N values. C/N was analyzed 5 times for each composter from day 0-60 during composting process. The value of C/N on day 0 for 1×2 day turning was 43.92; for 1×4 days, it was 44.52; after the process of composting, the value of C/N decreased drastically for 1×2 day turning to 32.90

and for 1×4 day turning to 37.70 on the 10th day. On the 20th day, the C/N value decreased by 1×2 days, turning 24.62, and by 1×4 days, turning 25.23. On the 30th day, the C/N value decreased for 1×2 days of turning to 18.65 and for 1×4 days of turning to 20.88. On the 40th day, the C/N value decreased for 1×2 days of turning to 16.42 and for 1×4 days of turning to 17.66. On the 60th day, the C/N value decreased for 1×2 days of turning to 14.83 and for 1 x 4 days of repair to 15.36. Reduced C levels during composting are the cause of the drop in the C/N ratio value. This happens as an outcome of the organic matter's breakdown due to microbial activity. [Siong et al., 2009]. The C/N ratio value is one of the critical indicators that indicate the maturity of compost [Baharuddin et al., 2009; Nutongkaew et al., 2011]. The initial EFB compost with *Azolla microphylla* had a C/N ratio of 43.92, and the final composting results showed a C/N ratio 14.83.

Effect of turning frequency on electrical conductivity

Electrical conductivity (EC) indicates the salinity leveling in compost object, which indicates the potential for phytotoxicity or phyto-inhibitory effects on microbes [Carballo et al., 2009]. Figure 8 shown effect of turning frequency on electrical conductivity.

The EC value of compost on day 0 for 1 x daily turning was 2679 $\mu\text{S}\cdot\text{cm}^{-1}$, 1×2 day turning 2670 $\mu\text{S}\cdot\text{cm}^{-1}$, 1×3 day turning 2575 $\mu\text{S}\cdot\text{cm}^{-1}$, 1×4

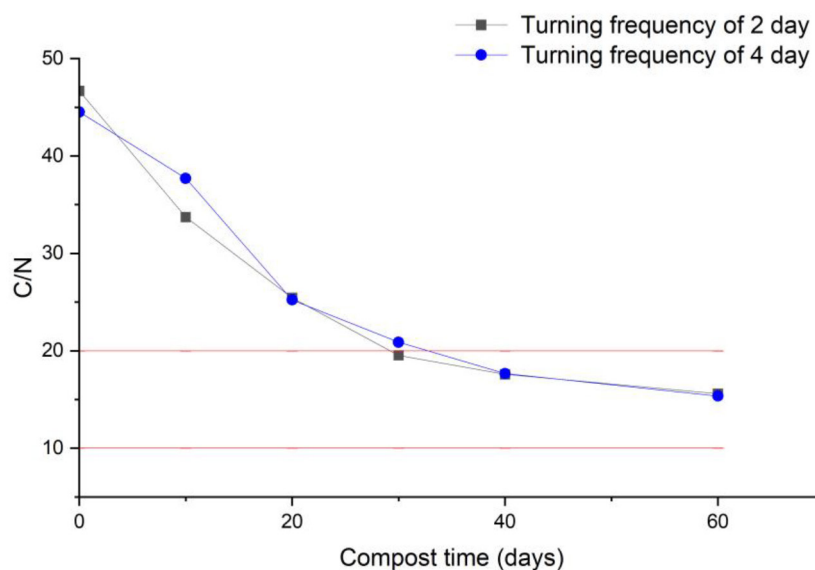

Figure 7. Effect of turning frequency on changes in C/N values

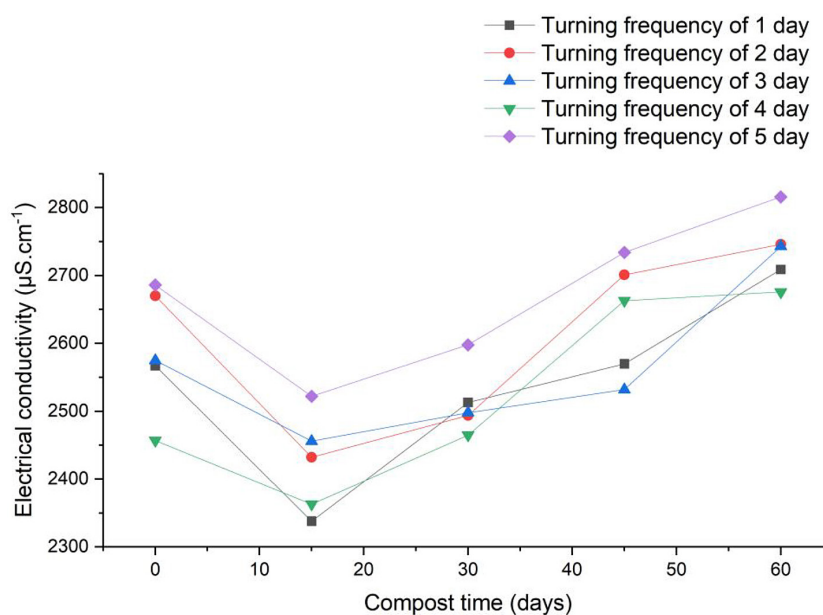

Figure 8. Effect of turning frequency on electrical conductivity

day turning $2457 \mu\text{S}\cdot\text{cm}^{-1}$, and 1×5 day turning $2686 \mu\text{S}\cdot\text{cm}^{-1}$. Then the EC value of the compost decreased until the 15th day, namely for turning $1\times$ a day $2338 \mu\text{S}\cdot\text{cm}^{-1}$, turning 1×2 days $2432 \mu\text{S}\cdot\text{cm}^{-1}$, for turning 1×3 days $2456 \mu\text{S}\cdot\text{cm}^{-1}$, for turning 1×4 days $2363 \mu\text{S}\cdot\text{cm}^{-1}$, and for turning 1×5 days $2522 \mu\text{S}\cdot\text{cm}^{-1}$. The decrease in the electrical conductivity value in day 0 to day 30 is related to activity of bacterial in the biodegradation process, which increases in the early stages of composting. This is to what was reported by Budi et al. and Carballo et al., that in the early stages of composting, bacteria will decompose organic matter into NH^+ , CO , water vapor, and heat, increasing the concentration of NH^+ will decrease the electrical conductivity value [Anonymous, 2006; Sekarsari, 2011]. Then, the EC value increased from the 30th day to the 60th day. The ultimate EC value following this composting procedure for turning $1\times$ a day was $2746 \mu\text{S}\cdot\text{cm}^{-1}$, turning 1×2 days was $2746 \mu\text{S}\cdot\text{cm}^{-1}$, turning 1×3 days was $2743 \mu\text{S}\cdot\text{cm}^{-1}$, turning 1×4 days $2676 \mu\text{S}\cdot\text{cm}^{-1}$, and turning 1×5 days was $2816 \mu\text{S}\cdot\text{cm}^{-1}$. The increase in the EC value indicates that bacterial activity in the biodegradation process has decreased.

Effect of turning frequency on average temperature and MC

In the composting process, the frequency of Turning can affect the composting rate and the quality of the compost produced [Ogunwande et

al., 2008]. Temperature is the most important thing to measure in the composting process [Putra et al., 2013]. Figure 9 shown effect of turning frequency on average temperature and average moisture content. The average temperature for variations in the frequency of turning $1\times$ a day, 1×2 days, 1×3 days, 1×4 days, 1×5 days once is 29.62°C ; 29.92°C ; 30.81°C ; 31.11°C ; and 31.28°C . The effect of the frequency of turning on the temperature can be seen in the graph; the lowest average temperature is produced by the variation of the frequency of turning $1\times$ a day, namely 29.62°C , and the highest average temperature is produced by turning 1×5 days, namely 31.28°C . This shows a correlation: the more frequently the stirring is given, the lower the pile temperature will be, although, in this study, the difference was not significant. This is what was stated by Shen et al. (2010); the pile's temperature will be lower due to the cooling effect of the composter caused by the high circulation frequency [Shen et al., 2011].

One of the most important elements that needs to be preserved during the composting process is the moisture content. [Saidi et al., 2008]. Baharudin et al. (2010) claimed that 55–65% MC is the ideal MC condition for composting. [Baharuddin et al., 2010]. If the MC is too high, it can inhibit the growth of microorganisms because water molecules will fill the air cavity, so anaerobic conditions occur due to lack of air [Junus et al., 1998; Sundberg et al., 2004]. In graph 4.6, the average MC for the variation of the turning frequency of $1\times$ a day, 1×2 days, 1×3 days, 1×4

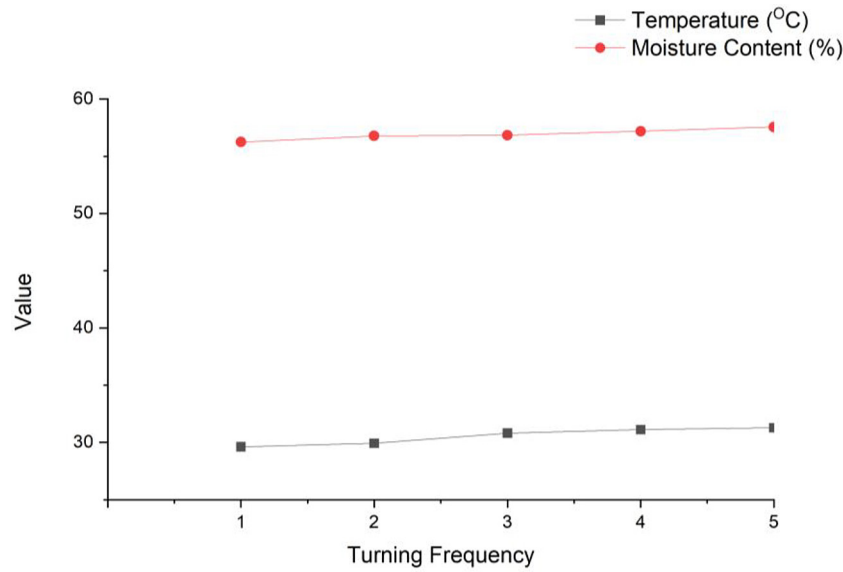

Figure 9. Effect of turning frequency on average temperature and average moisture content

days, and 1×5 days is 56.24%; 56.77%; 56.84%; 57.05%; and 57.32%. From the experimental data for each variation of the turning frequency, it is still in the MC range of 55–58%. This is based on the quality of compost maturity MC, namely 55–65% [Sundberg et al., 2004].

Effect of turning frequency on pH

During the composting process, the pH in each composter showed different changes. The change in pH during the composting process was caused by microbial activity [UNEP, 2005; Kananam et al., 2011]. The average pH value for each variation of the turning frequency was 8.774, 8.752, 8.748, 8.739, and 8.728. The pH values

obtained during composting tended to be alkaline. The pH value in alkaline conditions is good for the composting process. Because alkaline conditions can inhibit the growth of pathogens, such as fungi that can live in acidic conditions [Saidi et al., 2008]. Figure 10 shows that the highest average pH is found in the 1× daily turning frequency variation, while the lowest is in the 1×5-day turning frequency variation. So, it can be concluded that the more frequent the turning, the greater the compost pH will be, even though the difference is not significant. This is to the theory that stirring can release CO₂ stuck in the voids between the particles of compost, thus prevent conditions of the acidic in the pile or a decrease in pH [Sekman et al., 2011; Liu and Cai, 2014].

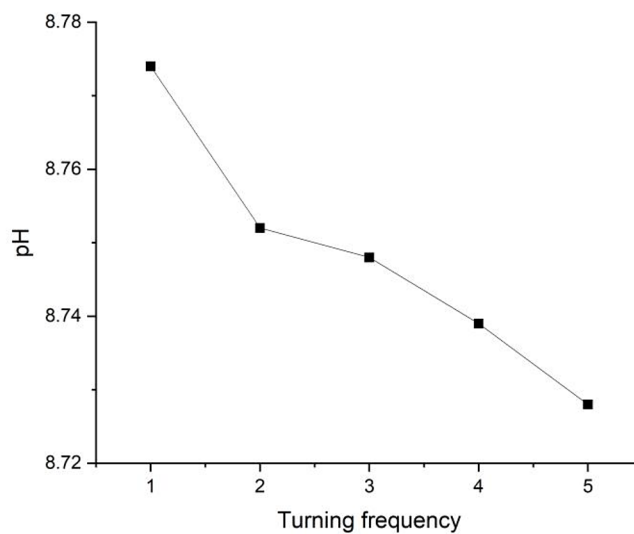

Figure 10. Effect of turning frequency on pH changes

Compost mass shrinkage of each composter during the composting process

During the composting process, measurements of the compost mass in each composter were carried out. Figure 11 shows that the shrinkage of the compost mass is getting smaller along with the composting time, although there is an increase in the compost mass at several points; this is caused by the addition of active organic fertilizer, which increases the compost mass. The initial mass of each composter is 2 kg. Mass shrinkage occurs drastically for the first 4 days, then after the first 4 days, the compost mass shrinkage decreases until the 60th day. From the data obtained, the final mass shrinkage at 1× daily turning is 108 kg, at 1×2 day turning is 108 kg, at 1×3 day turning is 1.09 kg, at 1×4 day turning is 1.1 kg, and at 1×5 day turning is 1.05 kg.

Comparison to previous research

This study investigated the use of *Azolla microphylla* and active organic fertilizer in the composting of empty fruit bunches to evaluate its

potential as a sustainable and effective alternative to composting methods. To better understand the significance of this approach, the results were compared with previous studies on alternative methods of processing EFB. The comparison provides insights into this approach performs dynamic to existing approaches in terms of key compost parameters, including pH, moisture content, water holding capacity, electrical conductivity, and the carbon-to-nitrogen (C/N) ratio. Table 4 shows the comparison the results of this study with previous research, showing differences in raw materials, composting methods, and compost quality.

Table 4 shows the summary of composting parameters for EFB with alternative composter type. To compare the results of this study with previous research, it must be done by comparing the same raw materials, in this case EFB. Table 4 shows that using *Azolla microphylla* and AOF in this study resulted in a C/N ratio of 14.83, which indicates mature compost and is closer to the ideal range than other methods. In addition, the C/N ratio adheres to the standard specified by SNI 19-7030-2004, which ranges from 10 to 20 [Anonymous, 2004], and thus remains within the

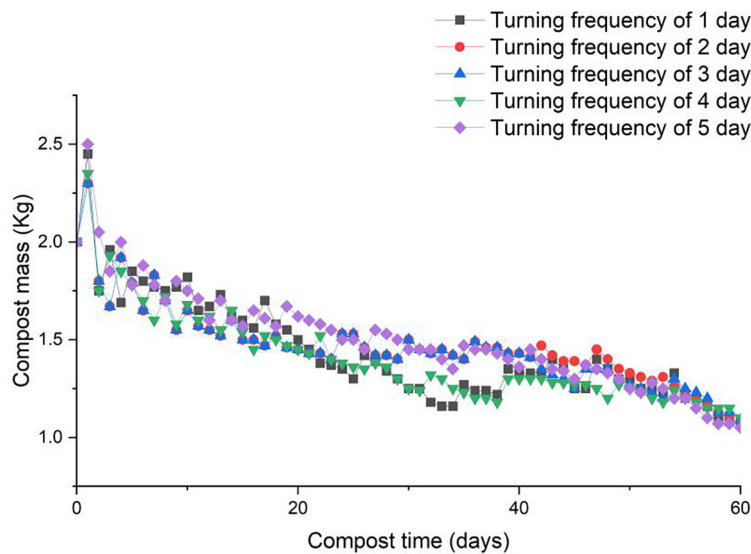

Figure 11. Compost mass shrinkage over time

Table 4. Summary of composting parameters for EFB with alternative composter type

Raw materials	Composter type	pH	MC (%)	WHC (%)	EC (µs/cm)	C/N ratio	References
EFB and palm oil mill effluent	Windrow composting	9	52.59	76	–	12.15	[Baharuddin et al., 2010]
EFB and palm oil mill effluent	Rotary drum	7.6	70	–	–	13.06	[Alkarimiah and Suja, 2020]
EFB and <i>Trichoderma</i> strains	Plastic bags	4	–	–	50.40	3.33	[Siddiquee et al., 2017]
EFB, <i>Azolla microphylla</i> , and AOF	Basket	8.7	55.72	77	2746	14.83	This study

acceptable range. The MC obtained is higher than that reported by Baharuddin et al., and lower than the values presented by Alkarimiah and Suja, yet it remains within their reported range. The MC and WHC were good, helping microbes grow and retain nutrients. The pH of 8.7 in this study is below the pH that reported by Baharuddin et al., which is base. The base pH obtained is suitable for plant growth. The EC value of 2746 $\mu\text{S}/\text{cm}$ was higher than Siddiquee et al. This means the compost is rich in nutrients.

The type of composter plays a crucial role in determining the efficiency of composting, influencing parameters such as aeration, moisture retention, microbial activity, and overall compost quality. Table 4 shows some type of composter namely windrow composting, rotary drum, plastic bags and basket. The basket composter used in this study showed advantages in maintaining parameters. The compact design of the basket composter facilitates better retention of moisture and nutrients, which supports *Azolla microphylla* and AOF activity. While the basket composter demonstrated favorable results, its capacity is relatively limited compared to rotary drum or windrow systems, which can handle larger volumes of material. This could pose scalability challenges for large-scale operations. Overall, the basket composter presents a viable alternative for small to medium-scale composting operations, particularly when paired with innovative additives like *Azolla microphylla* and AOF. Its ability to maintain favorable composting conditions suggests it could be a practical choice for localized waste management systems, complementing larger-scale methods such as rotary drum composting.

CONCLUSIONS

Research on making compost from empty fruit bunches by adding *Azolla microphylla* with active organic fertilizer and the effect of turning frequency has been successfully carried out. The values of moisture content, temperature, EC and pH, respectively, at turning once a day were 53.93%; 29.62 °C; 2,709 $\mu\text{S}/\text{cm}$; 8.9 at turning once every 2 days were 55.72%; 29.92 °C; 2,746 $\mu\text{S}/\text{cm}$; and 8.7 at turning once every 3 days were 53.30%; 30.81; 2,743 $\mu\text{S}/\text{cm}$; and 8.7 at turning once every 4 days were 54.23%; 31.11 °C; 2,676 $\mu\text{S}/\text{cm}$; and 8.6 at turning once every 5 days were 54.96%; 31.28 °C; 2.816 $\mu\text{S}/\text{cm}$; and 8.6.

The C/N values on days 0, 10, 20, 30, 40, and 60 obtained from the composting of EFB and *Azolla microphylla* with a mixture of AOF in composter 2 were 43.92; 33.48; 24.62; 18.65; 16.42; 14.83. The best compost quality was produced in a composter with a 2-day turning variation with the characteristics of pH 8.7; MC 55.72%, WHC 77%, C 20.17%, N 1.36%, and a C/N ratio of 14.83.

REFERENCES

1. Alkarimiah, R., Suja, F. 2020. Composting of EFB and POME Using a Step-Feeding Strategy in a Rotary Drum Reactor: The Effect of Active Aeration and Mixing Ratio on Composting Performance. Polish Journal of Environmental Studies 29.
2. Anonymous 2016. Outlook: Kelapa Sawit.
3. Anonymous 2014. Statistik Kelapa Sawit Indonesia 2014, Badan Pusat Statistik Indonesia. Jakarta.
4. Anonymous 2006. Keputusan Menteri Pertanian Nomor 2/pert/HK.060/2/2006 Tentang Persyaratan Teknis Minimal Pupuk Organik. Jakarta.
5. Anonymous 2004. SNI 19-7030-2004: Spesifikasi kompos dari sampah organik domestik, Standar Nasional Indonesia. Jakarta.
6. Anonymous 1996. Program Langit Biru.
7. Association, K.I.T.-C. 2007. Separation at Source, Collection and Composting of Waste in Surabaya, Indonesia: Promoting the Reduction and Recycling of Waste. Report Project 2004-2006.
8. Baharuddin, A.S., Hock, L.S., Yusof, M.Z.M., Rahman, N.A.A., Shah, U.K.M., Hassan, M.A., Wakisaka, M., Sakai, K., Shirai, Y. 2010. Effects of palm oil mill effluent (POME) anaerobic sludge from 500 m³ of closed anaerobic methane digested tank on pressed-shredded empty fruit bunch (EFB) composting process. African Journal of Biotechnology 9, 2427–2436. <https://doi.org/10.5897/AJB2010.000-3053>
9. Baharuddin, A.S., Wakisaka, M., Shirai, Y., Abd-Aziz, S., Abdul Rahman, N.A., Hassan, M.A. 2009. Co-composting of empty fruit bunches and partially treated palm oil mill effluents in pilot scale. International Journal of Agricultural Research 4, 69–78. <https://doi.org/10.3923/ijar.2009.69.78>
10. Carballo, T., Gil, M. V., Calvo, L.F., Morán, A. 2009. The Influence of Aeration System, Temperature and Compost Origin on the Phytotoxicity of Compost Tea. Compost Science and Utilization 17, 127–139. <https://doi.org/10.1080/1065657X.2009.10702411>
11. Ghanimeh, S., El Fadel, M., Saikaly, P. 2012. Mixing effect on thermophilic anaerobic digestion of source-sorted organic fraction of municipal solid waste. Bioresource Technology 117, 63–71. <https://doi.org/10.1016/j.biortech.2012.02.125>

12. Gotaas, H.B. 1956. Composting; sanitary disposal and reclamation of organic wastes. Monograph Series. World Health Organization 1–205. <https://doi.org/10.4269/ajtmh.1957.6.1.tm0060010192a>
13. Junus, M., Widodo, E., Djunaidi, I.H. 1998. Laporan penelitian tahun II: rekayasa penggunaan sludge limbah ternak sebagai bahan pakan dan pupuk cair tanaman. Fakultas Peternakan Universitas Brawijaya.
14. Kananam, W., Suksaroj, T.T., Suksaroj, C. 2011. Biochemical changes during oil palm (*Elaeis guineensis*) empty fruit bunches composting with decanter sludge and chicken manure. *ScienceAsia* 37, 17–23. <https://doi.org/10.2306/scienceasia1513-1874.2011.37.017>
15. Karagiannidis, A., Theodoseli, M., Malamakis, A., Bilitewski, B., Reichenbach, J., Nguyen, T., Galang, A., Parayno, P. 2010. Decentralized aerobic composting of urban solid wastes: Some lessons learned from ASIAN-EU cooperative research. *Global Nest Journal* 12, 343–351. <https://doi.org/10.30955/gnj.000497>
16. Liu, H.T., Cai, L. 2014. Effect of Sewage Sludge Addition on the Completion of Aerobic Composting of Thermally Hydrolyzed Kitchen Biogas Residue. *BioResources* 9, 4862–4872. <https://doi.org/10.15376/biores.9.3.4862-4872>
17. Nutongkaew, T., Duangsuwan, W., Prasertsan, S., Prasertsan, P. 2011. Production of Compost from Palm Oil Mill Biogas Sludge Mixed with Palm Oil Mill Wastes and Biogas Effluent. *TIChE International Conference*. 1–5.
18. Ogunwande, G.A., Ogunjimi, L.A.O., Fafiyebi, J.O. 2008. Effects of turning frequency on composting of chicken litter in turned windrow piles. *International Agrophysics* 22, 159–165.
19. Putra, H.P., Hakim, L., Yuriandala, Y., K, D.A. 2013. Studi Kualitas Briket dari Tandan Kosong Kelapa Sawit dengan Perikat Limbah Nasi. *Jurnal Sains & Teknologi Lingkungan* 5, 27–35. <https://doi.org/10.20885/jstl.vol5.iss1.art4>
20. Saidi, N., Chérif, M., Jedidi, N., Mahrouk, M., Fumio, M., Boudabous, A., Hassen, A. 2008. Evolution of biochemical parameters during composting of various wastes compost. *American Journal of Environmental Sciences* 4, 333–341. <https://doi.org/10.3844/ajessp.2008.332.341>
21. Sekarsari, N. 2011. Pengaruh Frekuensi Pengadukan Terhadap Proses Pengomposan Open Windrow (Studi Kasus: UPS Jalan Jawa, Kota Depok). Skripsi, Universitas Indonesia, Depok.
22. Sekman, E., Top, S., Varank, G., Bilgili, M.S. 2011. Pilot-scale investigation of aeration rate effect on leachate characteristics in landfills. *Fresenius Environmental Bulletin* 20, 1841–1852.
23. Shen, Y., Ren, L., Li, G., Chen, T., Guo, R. 2011. Influence of aeration on CH₄, N₂O and NH₃ emissions during aerobic composting of a chicken manure and high C/N waste mixture. *Waste Management* 31, 33–38. <https://doi.org/10.1016/j.wasman.2010.08.019>
24. Siddiquee, S., Shafawati, S.N., Naher, L. 2017. Effective composting of empty fruit bunches using potential *Trichoderma* strains. *Biotechnology Reports* 13, 1–7.
25. Siong, L.H., Samsu, A.B., Najib, M.A., Kaisom, U.M., Ami, N.A.R., Abd-Aziz, S., Ali, M.A., Yoshito, S. 2009. Physicochemical Changes in Underow Co-Composting Process of Oil Palm Mesocarp Fiber and Palm Oil Mill Effluent Anaerobic Sludge. *Australian Journal of Basic and Applied Sciences* 3, 2809–2816.
26. Sudjana, B. 2014. Penggunaan Azolla Untuk Pertanian Berkelanjutan. *Jurnal Ilmiah Solusi* 1, 3–8.
27. Suhaimi, M., Ong, H.K. 2001. Composting empty fruit bunches of oil palm. *Malaysian Agricultural Research and Development Institute* 505, 1.
28. Sundberg, C., Smårs, S., Jönsson, H. 2004. Low pH as an inhibiting factor in the transition from mesophilic to thermophilic phase in composting. *Bioresource Technology* 95, 145–150. <https://doi.org/10.1016/j.biortech.2004.01.016>
29. Tambun, D. 2015. Pengaruh Ukuran Porongan Tandan Kosong Kelapa Sawit Pada Pembuatan Kompos dari Tandan Kompos Kelapa Sawit dan Pupuk Organik Aktif. Universitas Sumatera Utara.
30. Tiquia, S.M., Wan, J.H.C., Tam, N.F.Y. 2002. Dynamics of yard trimmings composting as determined by dehydrogenase activity, ATP content, arginine ammonification, and nitrification potential. *Process Biochemistry* 37, 1057–1065. [https://doi.org/10.1016/S0032-9592\(01\)00317-X](https://doi.org/10.1016/S0032-9592(01)00317-X)
31. Trisakti, B., Manalu, V., Taslim, I., Turmuzi, M. 2015. Acidogenesis of palm oil mill effluent to produce biogas: effect of hydraulic retention time and pH. *Procedia-Social and Behavioral Sciences* 195, 2466–2474.
32. UNEP 2005. Solid Waste Management [WWW Document]. URL <http://www.unep.or.jp/ietc/publication/spc/volII/14-Chapter8>.